

**4 x 90° ELBOWS MAXIMUM
(or equivalent)**

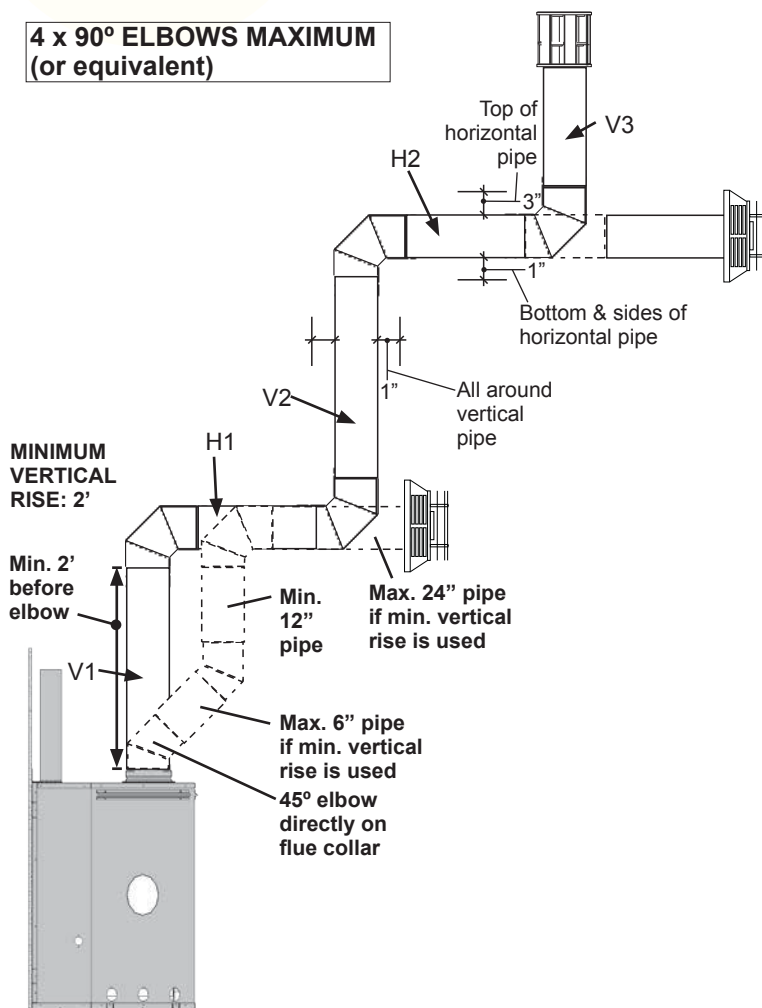

Example 1

$$V \text{ Value} = V1 (6') + V2 (6') + V3 (2') = 14'$$

$$H \text{ Value} = H1 (3') + H2 (3') = 6'$$

#2 Restrictor position required

Allowable Vent Configurations

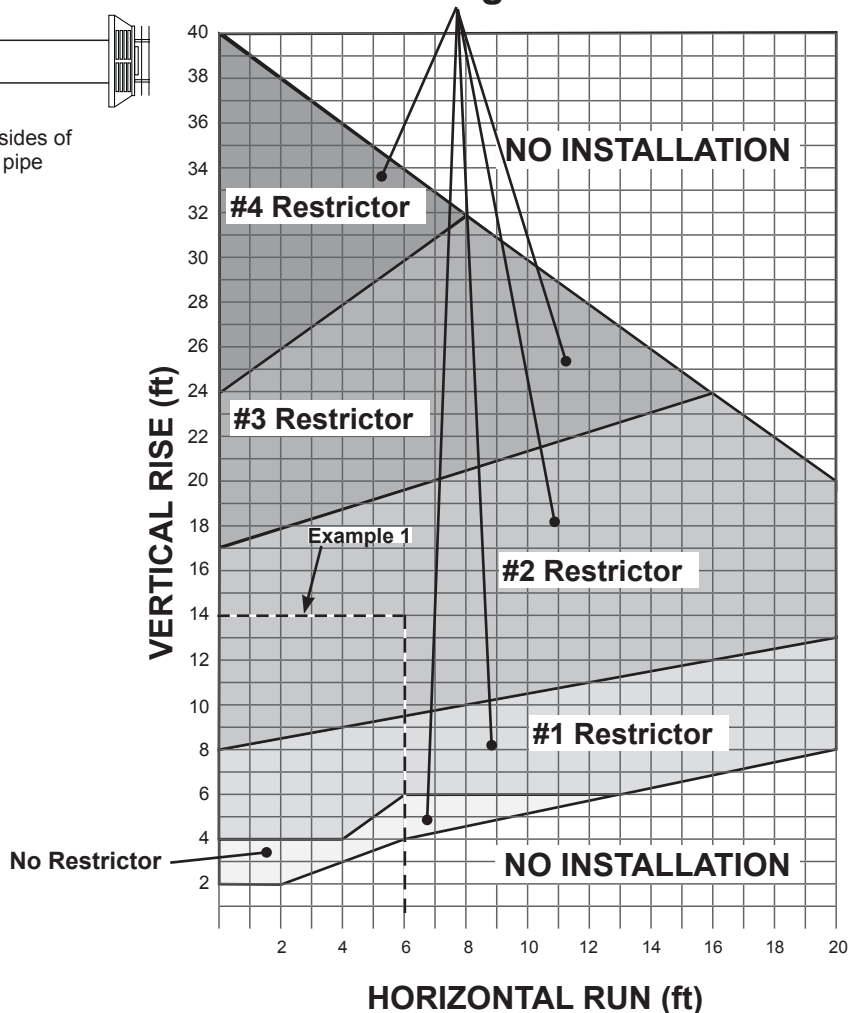

How to Read the Venting Chart

The chart below applies to roof or wall termination.

1. The total length of the vent pipe cannot exceed 40' (12.2m).
2. The minimum vertical height with roof termination is 6' (1.83 m).
3. Any combination of rise and run can be used as long as they are within the allowable limits shown on the chart below.
4. A maximum of 4 x 90° elbows—or equivalent (2 x 45° = 90°)—can be used.
5. Each 90° elbow installed on the horizontal plane is equivalent to a 3' horizontal pipe; therefore, 3' must be subtracted from

allowable horizontal run. (45° elbow is equivalent to 18" horizontal pipe.)

6. All horizontal pipe runs must be graded 1/4" per foot upwards in the direction of the exhaust flow. The final pipe length, when terminating through the wall may be graded downwards slightly to prevent water migration.
7. A restrictor is required for many installations—see installation manual for more information.

Conversion to Co-Linear Liners using generic Co-Linear Adapters

Co-linear portion of vent system may only be installed within a solid-fuel burning fireplace and chimney. The appliance must not be connected to a chimney flue serving a separate solid-fuel burning appliance. Requires a Co-Axial to Co-Linear appliance Adapter, two lengths of 2-ply 3" dia. flexible chimney liner approved for venting gas appliances, a co-linear termination kit and flashing or a co-linear to co-axial adapter and either a high wind vertical vent terminal cap or a low profile vertical termination. *Firebox top zero clearance stand-offs supplied with the heater are not required for this application.*

Rules for Co-Linear Venting

- Maximum 40 feet vertical pipe
- Minimum 10 feet vertical
- Maximum offset 8 feet with liners at minimum 45 degrees from horizontal plane
- Restrictor: Use #4 position for all co-linear installations—refer to page 31 for restrictor positioning.

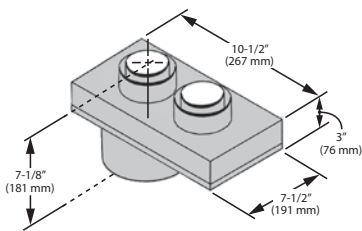

Dura-Vent #46DVA-GCL
Co-Axial to Co-Linear Adapter

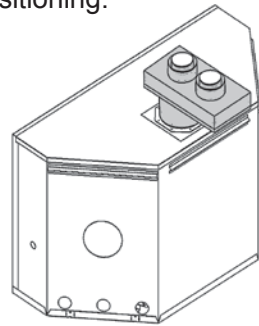

Ventana with co-linear adapter

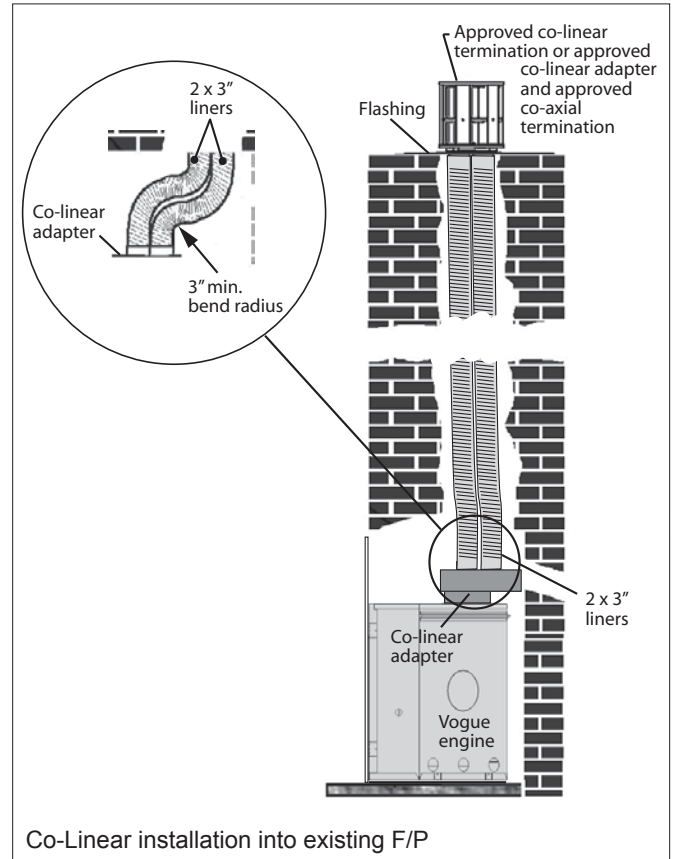

Co-Linear installation into existing F/P

Co-linear terminal configurations

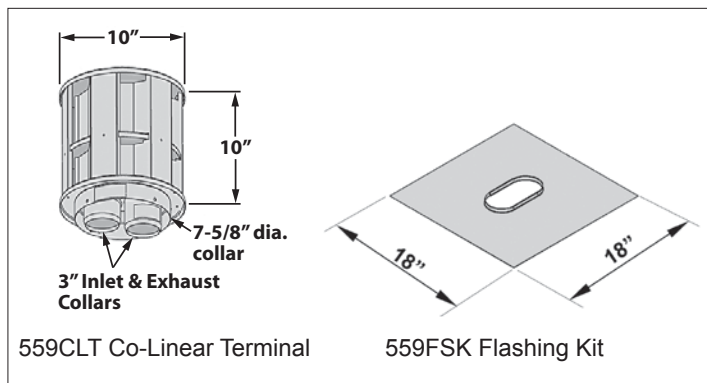

559CLT Co-Linear Terminal

559FSK Flashing Kit

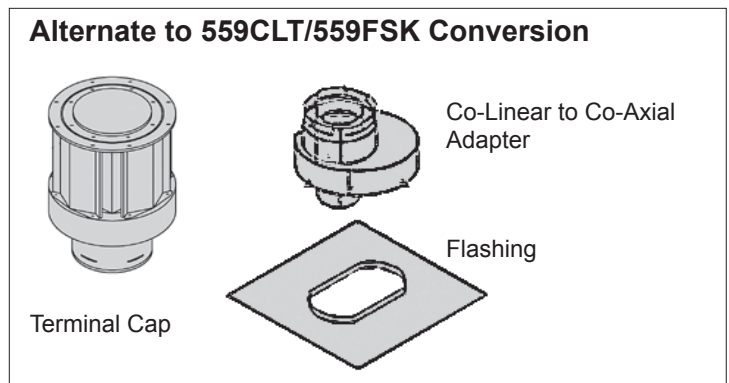

Alternate to 559CLT/559FSK Conversion

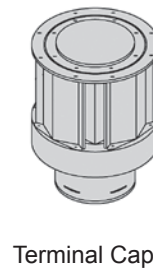

Terminal Cap

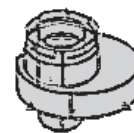

Co-Linear to Co-Axial
Adapter

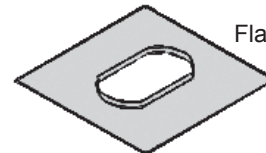

Flashing