

WALL CONTROLS

MAIN CONTROLS

Due to the constant evolution of our technologies, it may be possible that some control functions are not compatible to some earlier unit models. For more details, please refer to the compatibility chart on last pages.

All vănEE wall controls are user-friendly. They were created for people who want to maximise the benefits of their residential ventilation unit. With vănEE wall controls, the homeowner's specific needs are fulfilled.

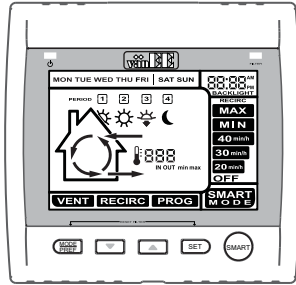

VC0104

PLATINUM
Part no. 40465

- Automatic and programmable control (keeps in memory all ventilation settings even after a power failure)
- Digital display with backlight (blue or green)
- Day, hour and periods of the day displayed
- Dynamic exchange and recirculation indicators, and also indoor and outdoors temperature
- Maintenance indicator

OPERATION MODES

SMART MODE SMART Mode

Our latest innovation! This mode optimizes automatically the ventilation functions to ensure reaching an unsurpassed comfort in the house.

VENT VENT MODE

In this mode, the air exchange with the outdoors is performed with the speed (OFF, MIN or MAX) or with a 20, 30 or 40-minute per hour cycle, according to the user's choice.

RECIRC RECIRC MODE

In this mode, the user decides to recirculate the air inside his house (OFF, MIN, MAX or OFF, MAX, according to the unit).

PROG PROG MODE

The ventilation unit operation is factory set for all 4 periods (morning, day, evening and night), for week days and week end days. However, these settings can be modified by the user to meet his own needs.



VC0120

DECO-TOUCH
Part no. 40300

- Allows the user to choose either the manual modes or the automatic mode (dehumidistat)
- 1" x 1" LCD display
- Digital display with blue backlighting
- Dynamic exchange and recirculation* indicators
- Interior relative humidity displayed
- Maintenance indicator

OPERATION MODES

RECIRC* Mode

In this mode, the air is recirculated inside the house at high speed.

20 MIN/H MODE

The ventilation unit exchanges air intermittently on a one-hour cycle as follows: OFF for 40 min. (or recirculation* on high or low speed for 40 min.) and then exchanges air during 20 min. on low speed. Repeats cycle after the 20 min. of air exchange.

MIN MODE

Air is exchanged with the outdoors on low speed.

MAX MODE

Air is exchanged with the outdoors on high speed.

HYGROMETER

In the operating modes listed above, select a dehumidistat override so that if the relative humidity (RH) in the house exceeds the RH setting previously stored, the ventilation unit will exchange in high speed until the target indoor RH setting is reached.

* Recirculation is not available to all units. For more details, please refer to the compatibility chart on last pages.

MAIN CONTROLS (CONT'D)

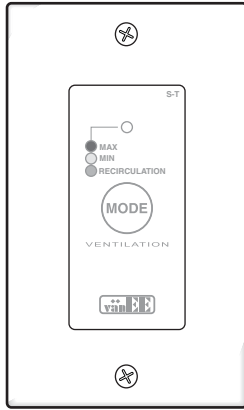

VC0146
SIMPLE-TOUCH BRONZE
Part no. 40290

The light indicator of this wall control shows clearly in which operating mode the unit is.

This push-button control has three functions:

- Recirculation (stops exchanging air with the outdoors and recirculates indoor air at high speed)
- Min (low speed air exchange)
- Max (high speed air exchange)

NOTE: Wall control appearance may slightly vary.

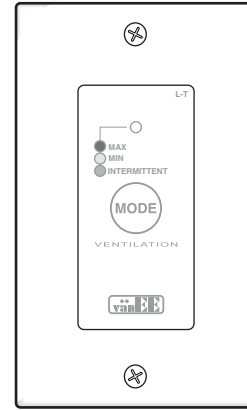

VC0147
LITE-TOUCH BRONZE
Part no. 40270

The light indicator of this wall control shows clearly in which operating mode the unit is.

This push-button control has three functions:

- Intermittent (unit is OFF during 40 minutes and then perform low speed air exchange with the outdoors during 20 minutes)
- Min (low speed air exchange)
- Max (high speed air exchange)

NOTE: Wall control appearance may slightly vary.

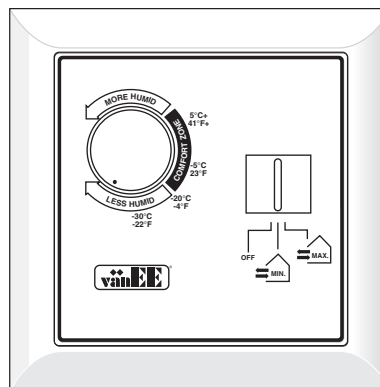

VC0039
BRONZE
Part no. 40250

The Bronze main control adjusts the air supply speed using the sliding button: OFF, MIN (low speed air exchange) and MAX (high speed air exchange). Also, the maximum humidity level for your house is selected using the knob.

AUXILIARY CONTROLS

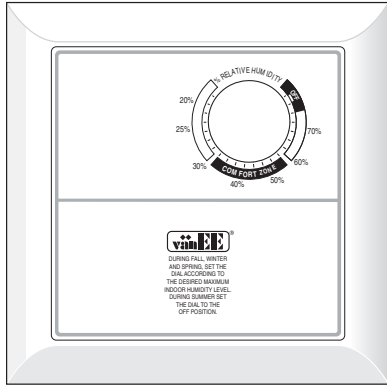

VC0038

DEHUMIDISTAT
Part no. 200694

The knob allows to adjust the maximum desired indoor humidity level during fall, winter and spring. This control is graduated in relative humidity percentage degrees. When a higher humidity level is detected, the unit turns on high speed until the situation is corrected.

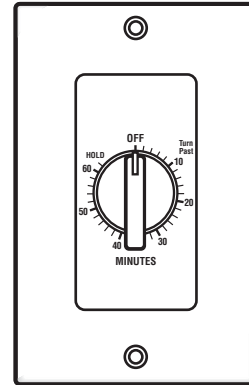

VC0017

60-MINUTE MECHANICAL TIMER
Part no. 00910

This timer allows for 10 to 60 minutes of high speed operation, to expel rapidly indoor stale air. Can be installed in bathrooms kitchen or laundry room.

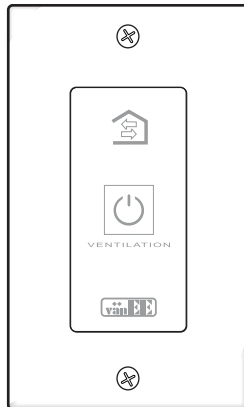

VC0142

20-MINUTE LIGHTED PUSH BUTTON
Part no. 1806110

This timer allows the unit to provide 20 minutes of high speed ventilation at the push of a button, to expel rapidly indoor stale air. Lighted when activated, up to five of them can be installed (e.g.: in bathroom, kitchen, laundry room, etc.).

NOTE: Push button appearance may slightly vary.

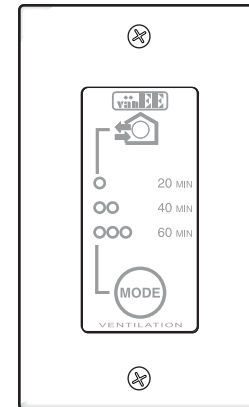

VC0144

20/40/60 MINUTE PUSH BUTTON
Part no. 03701

This timer allows the unit to turn on high speed during 20, 40 or 60 minutes to expel rapidly indoor stale air. Within 2 seconds, press once for 20 minutes, twice for 40 minutes or three times for a 60-minute activation. Press another time to deactivate.

NOTE: Push button appearance may slightly vary.

WALL CONTROL COMPATIBILITY CHART

The Dehumidistat, 60-minute crank timer and 20-minute push-button timer are compatible with all units.

Model no.	Name	Platinum version 3.01 Model no. 40460	Platinum version 4.04 Model no. 40465 (NOTE 1)	Deco-Touch version 2.01 Model no. 40295	Deco-Touch version 2.04 Model no. 40300 (NOTE 1)	Lite-Touch Bronze	Simple-Touch Bronze	Bronze	20/40/60 minutes
43915 & 43916	90H-V ECM ERV		PK0514 xxxxxxxx NOTE 2		PK0514 xxxxxxxx NOTE 2				
43905 & 43906	90H-V ECM HRV		PB0414 xxxxxxxx NOTE 2		PB0414 xxxxxxxx NOTE 2				
1601635	90H-V+		PC0314 xxxxxxxx NOTE 2		PC0314 xxxxxxxx NOTE 2				
1601620	60H-V+		PE3114 xxxxxxxx NOTE 2		PE3114 xxxxxxxx NOTE 2				
45405 & 48405	2000 HE & 3000 HE								
1601706 & 1601708	100H & 200H			NOTE 3	NOTE 3				
43828 & 45829	1001 VRC & 2001 VRC								
43808 & 45808	1001 VRE & 2001 VRE								
1601717 & 1601719	Novo+ 100H & Novo+ 200H								
44262 & 44263	40E		Qx3114 xxxxxxxx NOTE 2		Qx3114 xxxxxxxx NOTE 2				
44252 & 44253	40H+		Qx3114 xxxxxxxx NOTE 2		Qx3114 xxxxxxxx NOTE 2				
44600 & 44602	50H		Qx3114 xxxxxxxx NOTE 2		Qx3114 xxxxxxxx NOTE 2				
44250	40H								
41602 & 41600	HRV 60H	xxxx 0808 xxxxx NOTE 4	Bx0814 xxxxxxxx NOTE 2	xxxx 0808 xxxxx NOTE 4	Bx0814 xxxxxxxx NOTE 2				
41606 & 41604	ERV 60H	xxxx 0808 xxxxx NOTE 4	Bx0814 xxxxxxxx NOTE 2	xxxx 0808 xxxxx NOTE 4	Bx0814 xxxxxxxx NOTE 2				
41656 & 41654	60H+ ERV		Lx3114 xxxxxxxx NOTE 2		Lx3114 xxxxxxxx NOTE 2				
41652 & 41650	60H+ HRV								
41802	70E+ ERV								
41800	70E ERV			NOTE 3	NOTE 3				
41804	70Ec ERV								

NOTE 1: Wall control including configurable low speed recirculation in intermittent mode.

NOTE 2: Low speed recirculation in intermittent mode starts with this unit serial number. However, this control remains compatible with units with serial number under this one.

NOTE 3: Recirculation mode is not available for this unit.

NOTE 4: The compatibility starts from that unit serial number.

	Compatible
	Not compatible
Letters and numbers	This code is the serial number of the ventilation unit; consider only the letters and numbers mentioned, not the "xxx". E. g.: 90H-V ECM ERV with serial number PK05150004007 is fully compatible with Platinum version 4.03 and Deco-Touch version 2.04 (PK0515 is higher than PK0514).

Subject to change without prior notice.

WALL CONTROL COMPATIBILITY CHART

The Dehumidistat, 60-minute crank timer and 20-minute push-button timer are compatible with all units.

Model no.	Name	Platinum version 3.01 Model no. 40460	Platinum version 4.04 Model no. 40465 (NOTE 1)	Deco-Touch version 2.01 Model no. 40295	Deco-Touch version 2.04 Model no. 40300 (NOTE 1)	Lite-Touch Bronze	Simple-Touch Bronze	Bronze	20/40/60 minutes
1601630	90H-V			PD141211xxxx NOTE 3	PD141211xxxx NOTE 3				
1601605	60H Novo+		NOTE 2		NOTE 2				
1601606	90H								
1601608	190H								
1601607	90H Novo+								
1601609	190H Novo+								
44212 & 44213	Vigör ERV		NOTE 2		NOTE 2				
44222 & 44223	Vigör HRV Plus		NOTE 2		NOTE 2				
44200	Vigör HRV								
43405	1000 HE								

NOTE 1: Wall control including configurable low speed recirculation in intermittent mode.

NOTE 2: Compatible but low speed recirculation in intermittent mode is not available for this unit.

NOTE 3: The compatibility starts from that unit serial number, but recirculation mode is not available for this unit.

	Compatible
	Not compatible
Letters and numbers	This code is the serial number of the ventilation unit; consider only the letters and numbers mentioned, not the "xxx". Example: 90H-V with serial number PD14122504007 is fully compatible with Deco-Touch version 2.01 (PD141225 higher than PD141211).

Subject to change without prior notice.

